

M12 male / M12 female 0° shielded Cube67

PUR 0.5+0.25 shielded gn UL/CSA+drag ch. 20m

Cube67

Male straight – female straight

M12 – M12, 6-pole

shielded

A-coded

Hybrid cable

Plastic housings with good resistance against chemicals and oils.

The resistance to aggressive media should be individually tested for your application. Further details on request.

Further cable lengths on request.

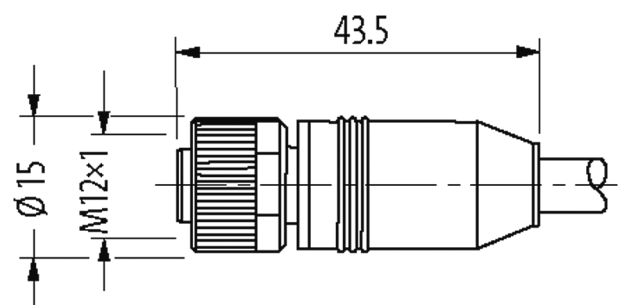
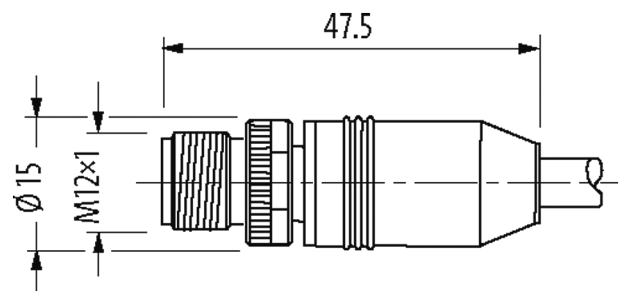
[Link to Product](#)**Illustration**

Product may differ from Image

Approvals

* only for products with UL/CSA approved cable

cCSAus

More Info

Cube67

Form

Form

46041

General data	
Mounting method	inserted, tightened
Material (contact)	Copper alloy
Material (contact surface)	Au
Material (gasket)	FKM
Pollution Degree	3
Temperature range	-25...+85 °C, depending on cable quality
Cables	
No./diameter of wires	4 × 0.5 + 2 × 0.25 mm ²
Wire isolation	TPE (bl, wh, br, bk), (gr, pk)
C-track properties	5 Mio.
Jacket Color	green
Material (jacket)	PUR (UL/CSA)
Outer Ø	7.9 mm ±5%
Bend radius (moving)	10 × outer Ø
Temperature range (fixed)	-50...+80 °C
Temperature range (mobile)	-40...+80 °C
Cable identification	802
Cable weight [g/m]	95,70
Material (wire)	Cu wire, bare
Single wire Ø (core)	0.15 mm (0.5 mm ²); 0.1 mm (0.25 mm ²)
Construction (core)	28 × 0.15 mm (0.5 mm ²); 32 × 0.1 mm (0.25 mm ²); (multi-strand wire class 6)
Diameter (core)	4 × 0.5 + 2 × 0.25 mm ²
AWG	similar to AWG 20 (0.5 mm ²); similar to AWG 24 (0.25 mm ²)
Material (wire isolation)	TPE-E
Shore hardness (wire isolation)	55 ±5 D
Wire-Ø incl. isolation	1.5 mm ±5% (0.5 mm ²); 1.4 mm ±5% (0.25 mm ²)
Color/numbering of wires	(bl, wh, br, bk) + (gr, pk)
Shield	yes
	min. 80%
Material (jacket)	PUR
Material property (jacket)	CFC-, halogen-, cadmium-, silicone-free, matt, low-adhesion, machine easy to process, abrasion-resistant
Shore hardness (jacket)	89 ±5 A
Outer-Ø (jacket)	7.9 mm ±5%
Color (jacket)	green
Nominal voltage	300 V AC
Test voltage	1500 V (wire/wire); 1200 V (wire/shield)
Temperature range (fixed)	-50...+80 °C
Temperature range (mobile)	-40...+80 °C
Bend radius (fixed)	5 × outer Ø
Bend radius (moving)	10 × outer Ø
No. of bending cycles (C-track)	max. 5 Mio. (25 °C)
Traversing distance (C-track)	max. 10 m
Travel speed (C-track)	max. 2 m/s
Torsion stress	±180°/m
Technical Data	
Operating voltage	max. 30 V AC/DC
Operating voltage (only UL listed)	30 V AC/DC

Rated surge voltage	0.8 kV
Operating current per contact	max. 4 A
No. of poles	6
Material group	IEC 60664-1, category I
Coding	A-coded
LED display	no
Locking of ports	Screw thread (M12×1 mm) recommended torque 0.6 Nm, self-securing
Compression gland	M12 (SW13)
Protection	IP65 and IP67 when plugged and screwed down (EN 60529)
Material	PUR
Locking material	Zinc die casting, matte nickel plated

Commercial data

country of origin	DE
customs tariff number	85444290
EAN	4048879140256
eClass	27061801
Packaging unit	1

Sketch



Male

Female



Product may differ from Image